











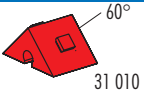

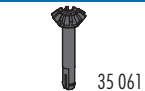

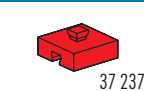

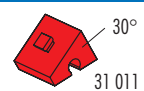
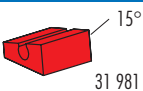

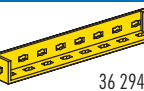
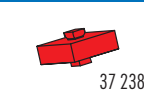



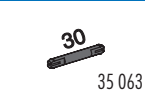
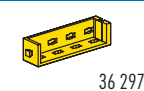

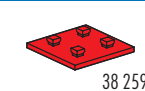

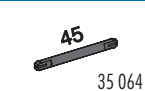

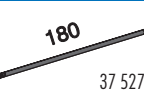

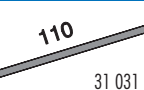

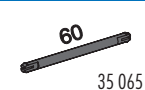

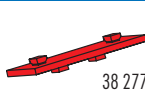
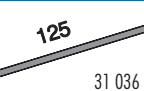
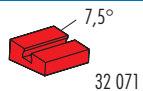
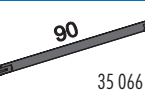
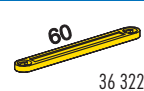
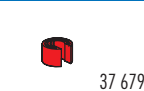
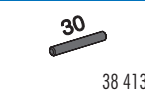
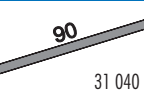
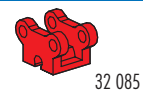

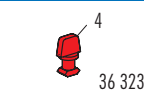
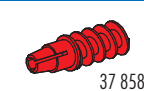
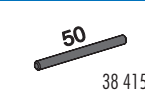

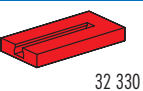

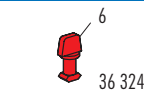

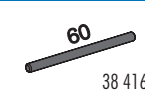
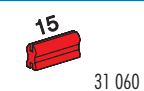
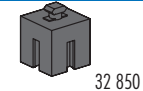
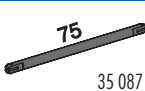

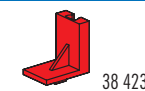
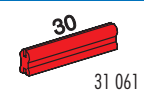
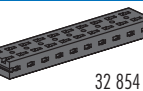
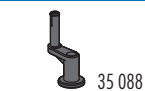
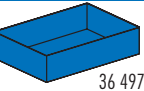

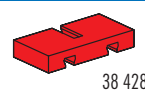

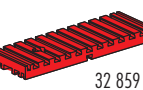
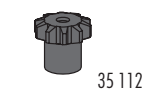
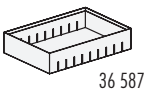
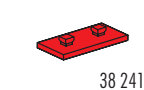
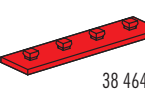
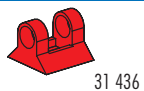
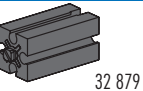

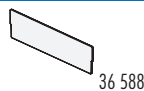
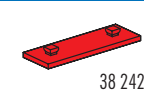
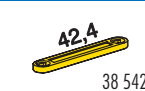
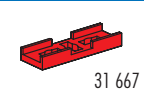
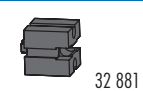
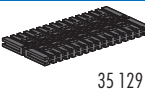
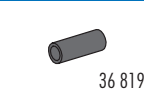
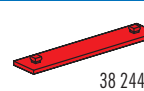
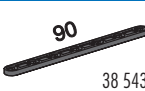
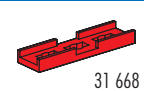
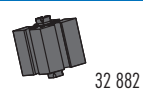
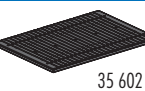

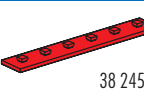
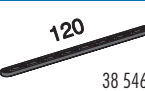
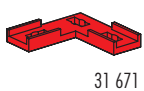
Creative Box 1000

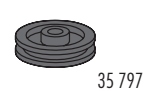
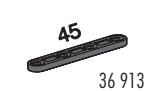
from www.procontech.com.au

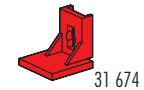
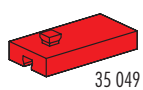
fischertechnik 

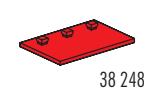
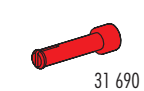
Einzelteilübersicht
Spare parts list
Liste des pièces détachées

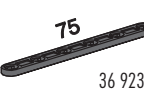
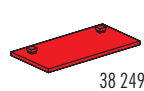
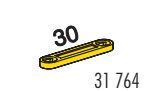
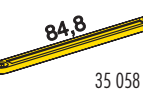
Onderdelenoverzicht
Lista da piezas
Resumo de peça individual

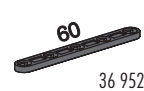
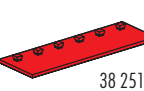
 31 010	6 x	 31 915	1 x	 35 061	2 x	 36 264	1 x	 37 237	10 x	 38 253	2 x
 31 011	6 x	 31 981	4 x	 35 062	2 x	 36 294	8 x	 37 238	10 x	 38 258	2 x
 31 021	2 x	 31 982	20 x	 35 063	2 x	 36 297	4 x	 37 468	10 x	 38 259	2 x
 31 022	1 x	 31 983	4 x	 35 064	2 x	 36 298	4 x	 37 527	1 x	 38 260	2 x
 31 031	1 x	 32 064	10 x	 35 065	2 x	 36 299	4 x	 37 636	4 x	 38 277	2 x
 31 036	1 x	 32 071	4 x	 35 066	2 x	 36 322	12 x	 37 679	20 x	 38 413	4 x
 31 040	1 x	 32 085	1 x	 35 073	6 x	 36 323	108 x	 37 858	1 x	 38 415	2 x
 31 058	4 x	 32 330	4 x	 35 076	4 x	 36 324	20 x	 37 925	1 x	 38 416	2 x
 31 060	20 x	 32 850	4 x	 35 087	2 x	 36 334	20 x	 37 926	2 x	 38 423	10 x
 31 061	10 x	 32 854	2 x	 35 088	1 x	 36 497	1 x	 38 240	4 x	 38 428	2 x
 31 426	2 x	 32 859	2 x	 35 112	1 x	 36 587	8 x	 38 241	8 x	 38 464	4 x
 31 436	4 x	 32 879	20 x	 35 113	1 x	 36 588	16 x	 38 242	4 x	 38 542	16 x
 31 667	2 x	 32 881	10 x	 35 129	2 x	 36 819	3 x	 38 244	2 x	 38 543	4 x
 31 668	2 x	 32 882	8 x	 35 602	1 x	 36 912	4 x	 38 245	4 x	 38 546	4 x
 31 671	2 x	 35 031	4 x	 35 797	2 x	 36 913	4 x	 38 246	4 x		
 31 674	4 x	 35 049	4 x	 35 945	2 x	 36 914	4 x	 38 248	2 x		
 31 690	4 x	 35 053	4 x	 36 227	4 x	 36 923	4 x	 38 249	2 x		
 31 764	8 x	 35 058	16 x	 36 248	102 x	 36 952	4 x	 38 251	4 x		

Montagehilfen und Hinweise
 Assembly aids and instructions
 Aides de montage et instructions

Montagehulpmiddelen en aanwijzingen
 Ayudas de montaje e instrucciones
 Montagens e indicações

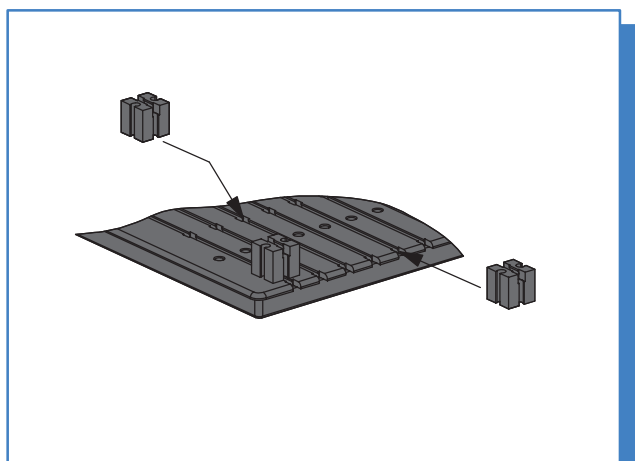
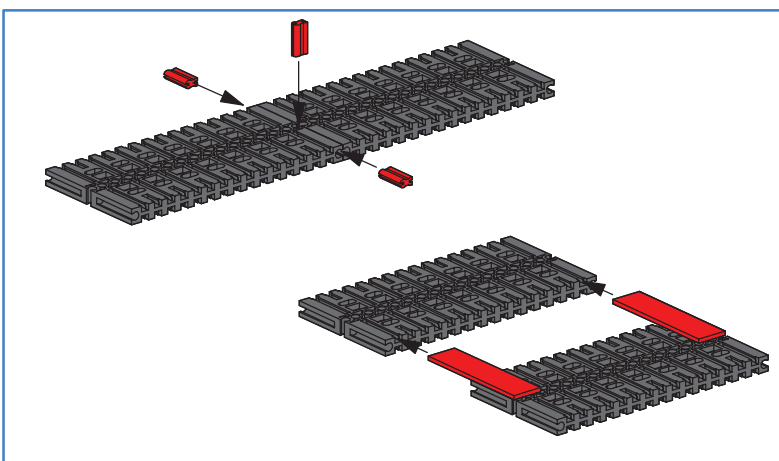
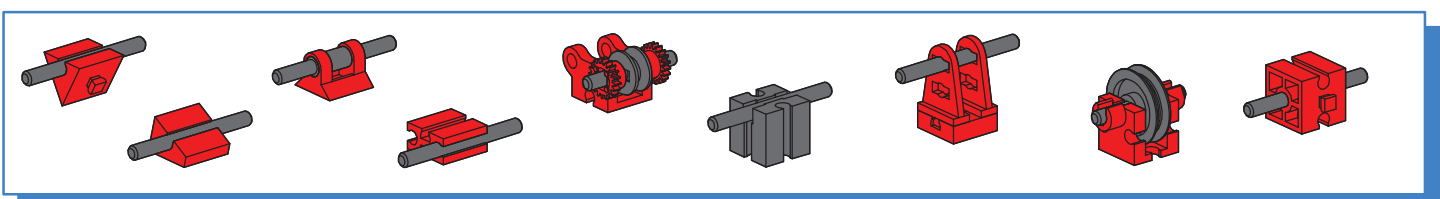
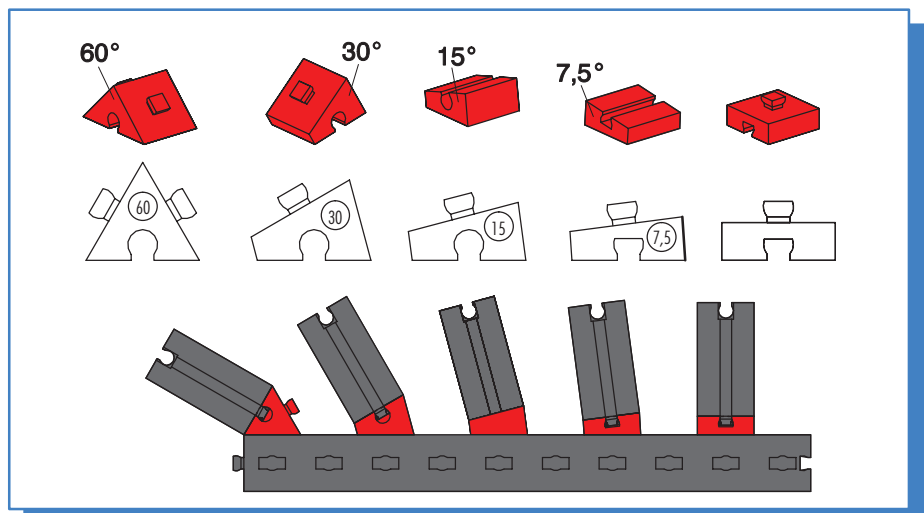
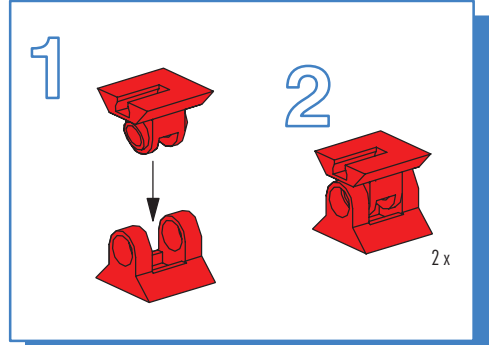
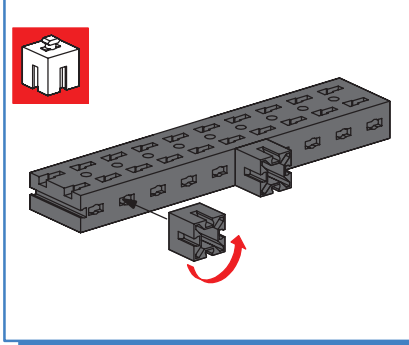
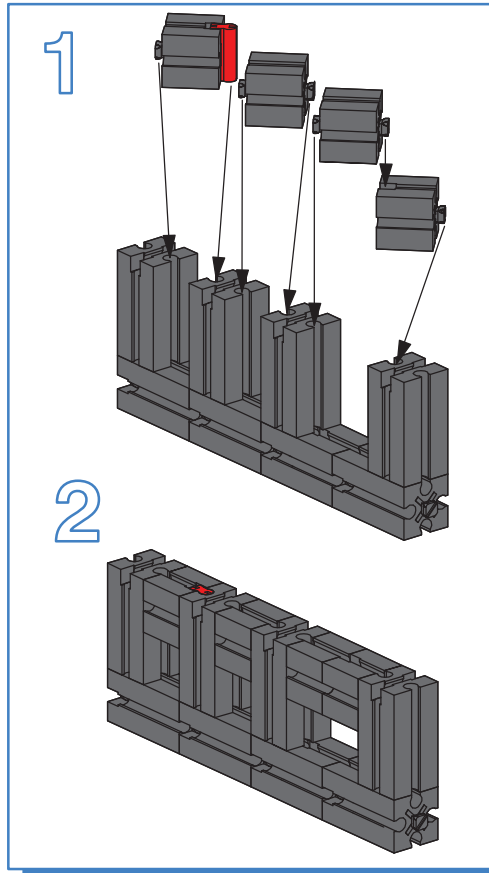
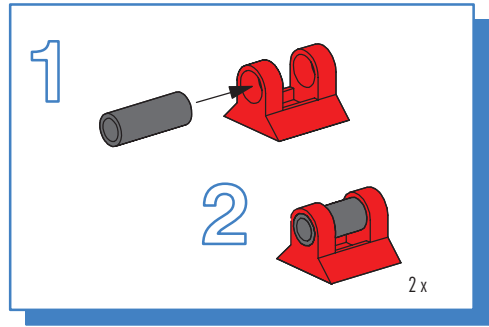
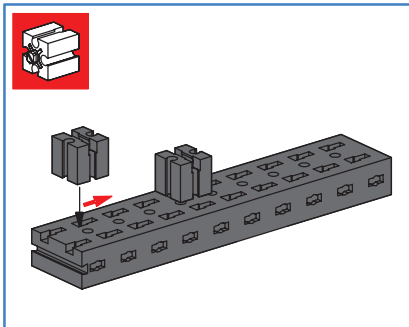
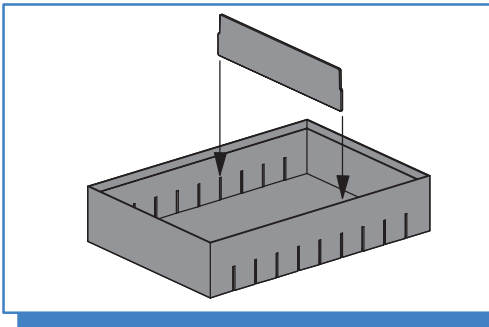

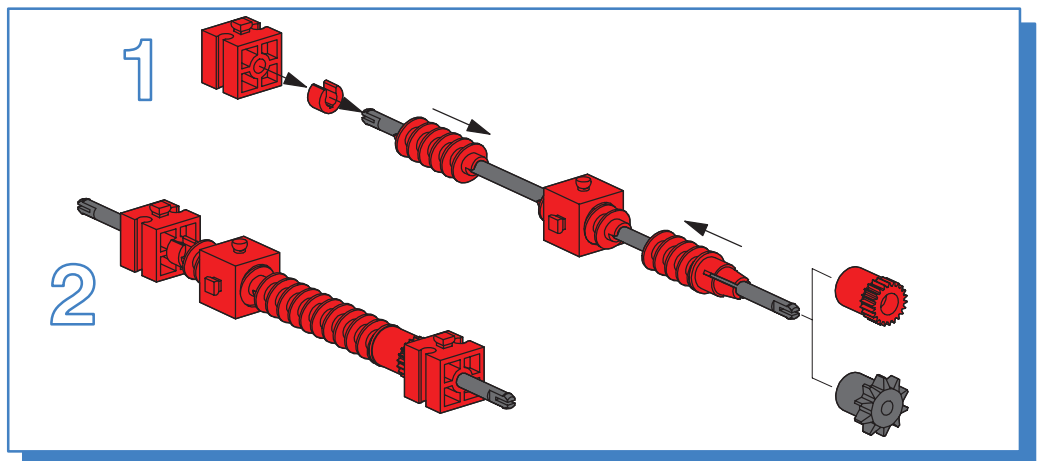
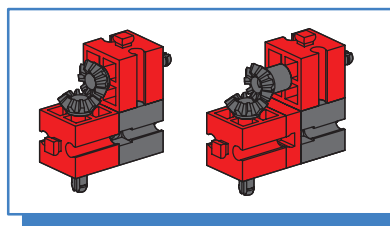
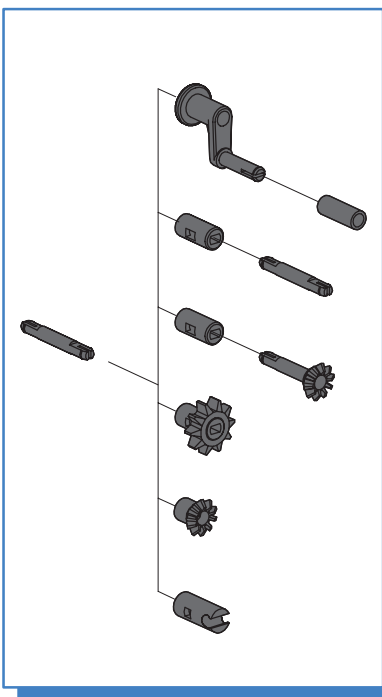
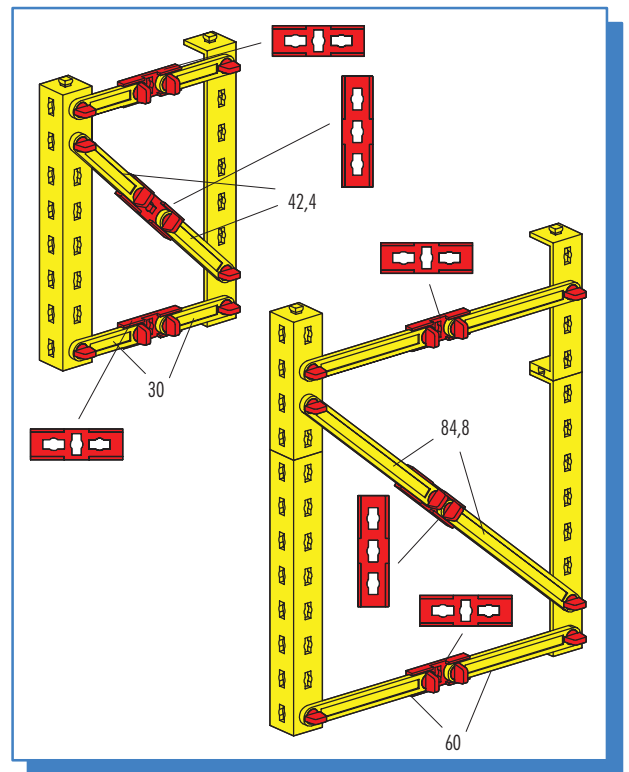
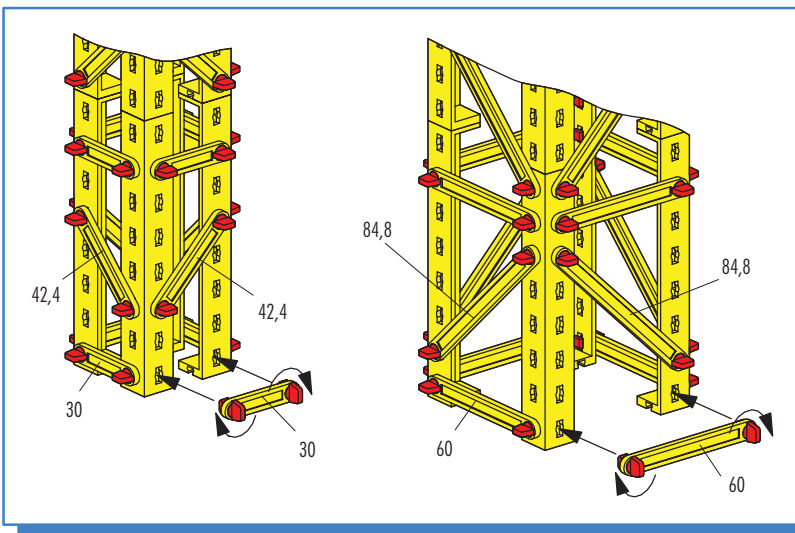
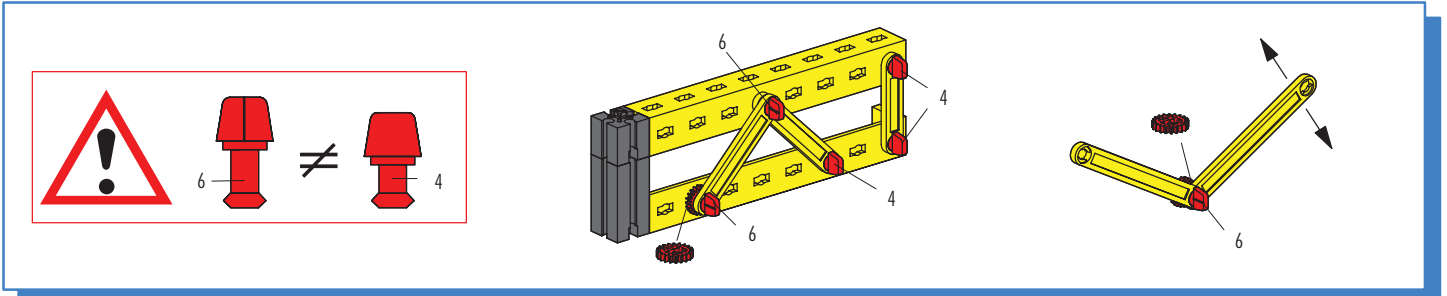
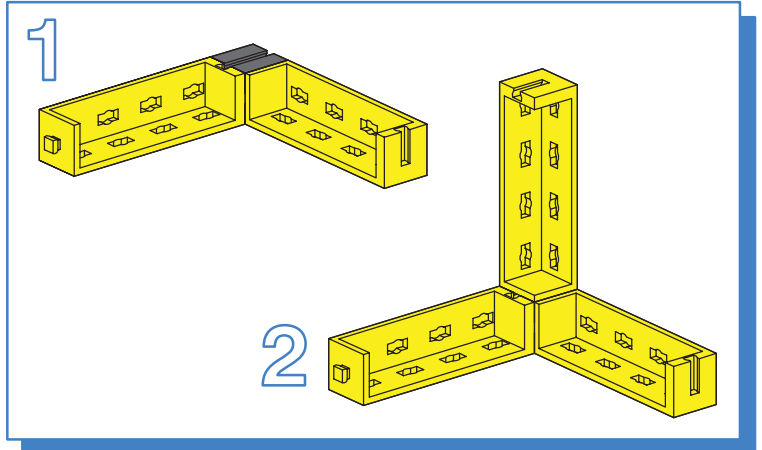
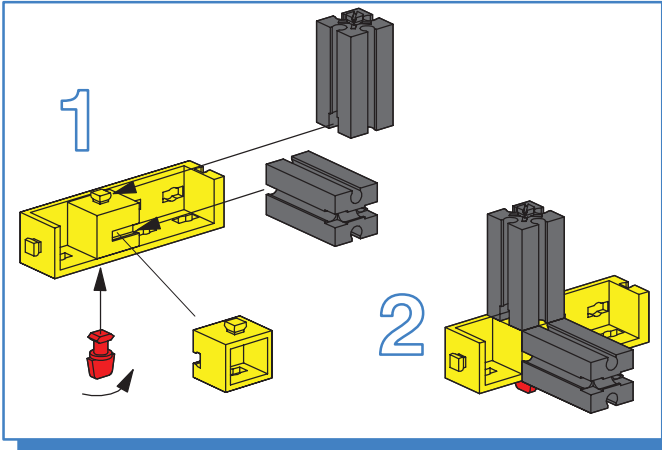

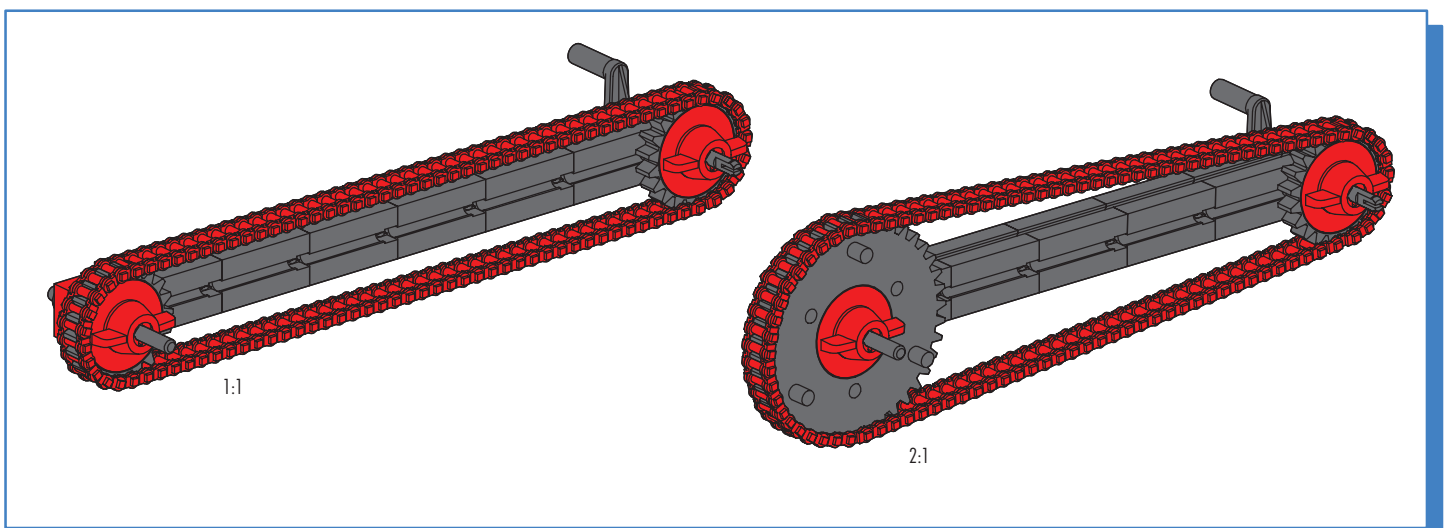
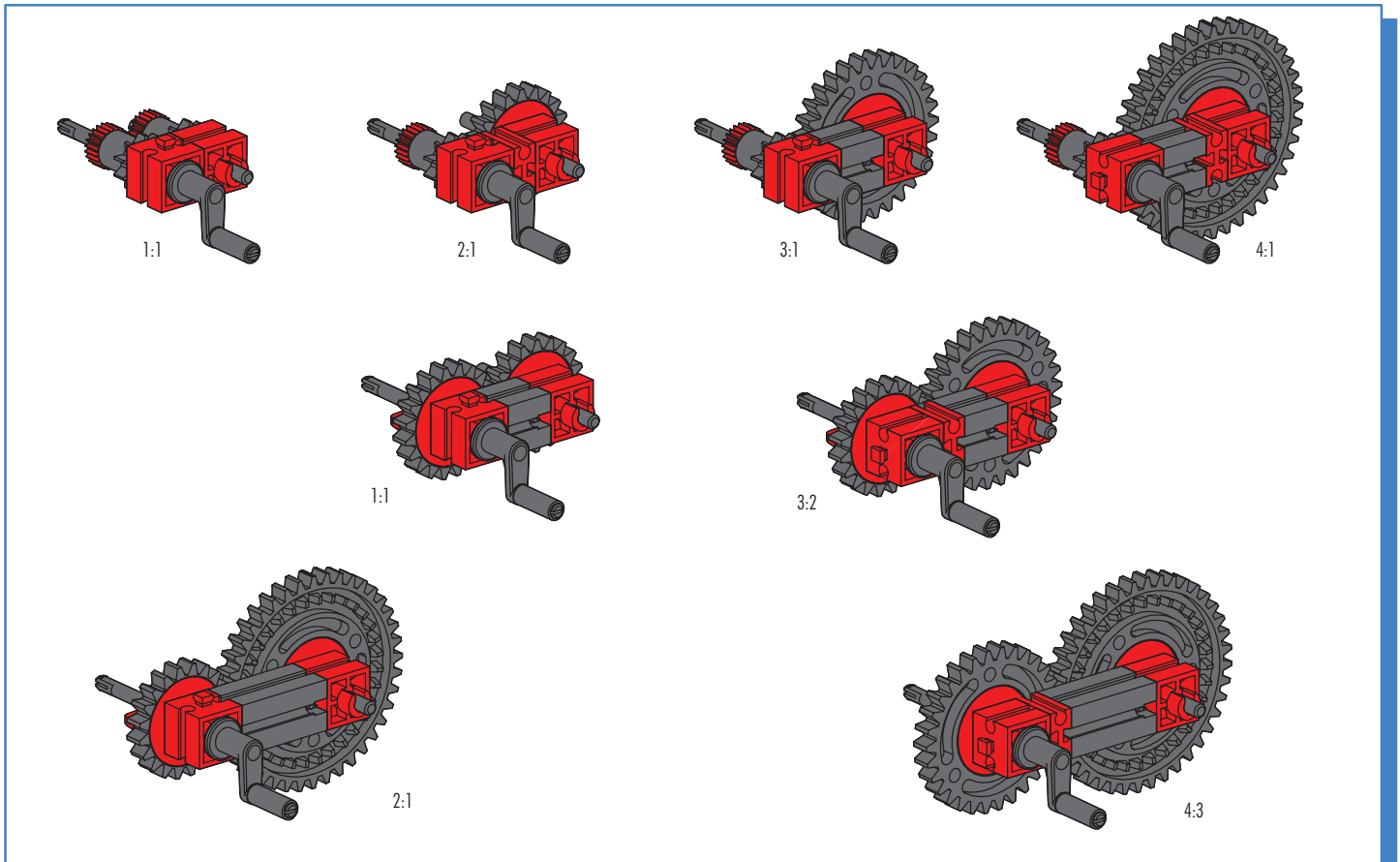
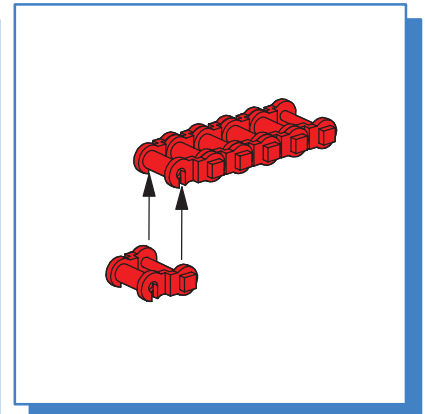
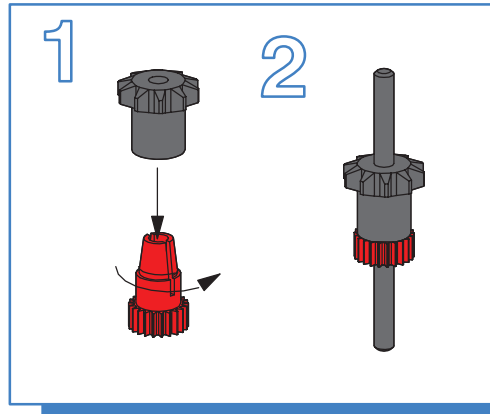
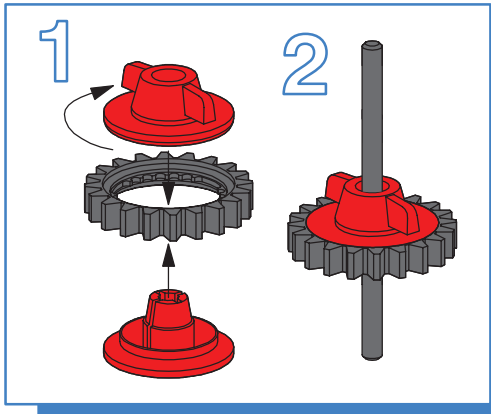

■ Alle Einzelteile, insbesondere bewegliche Teile sind falls notwendig zu warten und zu reinigen.
 ■ All components, especially moving parts, should be maintained and cleaned as necessary.
 ■ Toutes les pièces détachées et en particulier les pièces mobiles, sont, si nécessaire, à entretenir et à nettoyer.

■ Alle onderdelen, vooral de bewegende delen, kunnen, indien noodzakelijk, onderhouden en gereinigd worden.
 ■ Es necesario limpiar y mantener en buen estado todas las diferentes piezas - especialmente las piezas móviles.
 ■ Caso necessário, todas as peças individuais, especialmente peças móveis, tem que ser submetidas à manutenção e ser limpas.